



**Continental Disc®  
Corporation**

**HPX®**  
RUPTURE DISC  
PRODUCT FAMILY

HPX® & HPX®-TA RUPTURE DISCS  
HPX® INSERT, PRE-TORQUED & DOUBLE DISC HOLDERS  
SANITRX HPX®, SANITRX HPX® II & SANITRX® LPX RUPTURE DISCS  
SANITARY GASKETS, FITTINGS & CLAMPS



Representante Oficial  
Tel: +54 11 4932-2322  
Email: [ventas@cvcontrol.com.ar](mailto:ventas@cvcontrol.com.ar)  
[www.cvcontrol.com.ar](http://www.cvcontrol.com.ar)

# HPX<sup>®</sup>

RUPTURE DISC  
PRODUCT FAMILY



ALWAYS MOVING FORWARD

## ADVANCING TECHNOLOGY AND SAFETY... ONE INNOVATIVE DISC AT A TIME.

Built on years of research and development, the HPX and SANITRX<sup>®</sup> HPX Rupture Discs are high precision pressure relieving devices that protect personnel, equipment and the environment. The versatility of the HPX Product Family offers pressure protection for a wide range of applications in many processing industries, including: chemical, oil and gas, food, beverage, pharmaceutical, biotech, pulp and paper, power and more.

The HPX Product Family is the most advanced line of rupture discs available, incorporating proven performance in excess of **five million\* cycles**, operating up to 95% of burst pressure, and offered in a wide range of burst pressures, materials and sizes. These features support reduced down time and lower maintenance costs, increasing the productivity of your facility!

\*HPX<sup>®</sup> Rupture Discs were tested under laboratory conditions which may not reflect the end user's actual operating conditions. The cycle test validates that the rupture disc can operate in a pressure/vacuum operating condition. However, there are many other factors which can affect the rupture disc's performance, such as temperature variation, corrosion attack, etc. CDC recommends that a risk assessment be performed by customer/end user to consider their system operating conditions to determine the optimal service life for their rupture disc.



## Versatility & Reliability

Whether you need a rupture disc to meet the most demanding application requirements or a rupture disc to economically meet the needs of a less demanding one, the HPX and SANITRX HPX Rupture Disc product family is the solution for you.

The HPX and SANITRX HPX product family of rupture discs are available in various sizes, materials, ratings, manufacturing ranges and operating ratios to meet the performance criteria demanded by your application requirements.

**Designed for use in bolted flange or sanitary clamped installations, the HPX and SANITRX HPX Rupture Disc product family offer the following versatile features:**

**DISC SIZES** // HPX: 1" through 12"; SANITRX HPX: 1" through 3"; SANITRX HPX II: 1½" through 4"

**DISC MATERIALS** // 316 and 316L Stainless Steel, Nickel, MONEL®, INCONEL®, HASTELLOY® C, Tantalum<sup>1</sup>

**BURST PRESSURES** // 10 psig to 2000 psig (0,689 barg to 138 barg)

**MANUFACTURING RANGE** // Zero, -5% and -10%

**OPERATING RATIO** // Choice of 90% or 95% [see Burst Pressure Rating Types on pages 6 & 7](#)

**SAFETY RATIO** // 1 to 1 or less. If the rupture disc becomes damaged, it will relieve at or below the burst pressure

**DURABILITY** // Design tested for 5 million cycles<sup>2</sup> from full vacuum to the maximum operating pressure

**DESIGN** // Non-fragmenting, reverse acting, bubble-tight seal<sup>3</sup>

### HOLDERS

- > Carbon Steel, 316 SS, MONEL®, HASTELLOY® C materials
- > Tantalum holder options and fluoropolymer coatings available for extra corrosion protection
- > Insert, pre-torqued and double disc designs available
- > ASME, DIN and JIS bolting classes

### Reliability is assured through:

- > Advanced product design
- > Precise manufacturing technology
- > Extensive testing performed during the manufacturing process and lot qualification
- > Pre-shipment inspection
- > Unique packaging designed to protect your rupture discs in shipment, storage and handling at your plant site
- > Superior ability to operate in pressure-to-vacuum cycling applications

### CODES, STANDARDS & APPROVALS

When specified, the HPX product family will be manufactured in accordance with:

- > ASME Sect VIII, Sect III
- > ASME BPE<sup>4</sup>
- > Pressure Equipment Directive (PED)
- > ISO 4126-2
- > China Manufacturing License
- > GOST
- > KOSHA
- > 3A<sup>4</sup>

HPX PRODUCT FAMILY //

# INDUSTRIAL SOLUTIONS



ASME Code Symbol Stamp  
Available When Specified



Pressure Equipment Directive  
Available When Specified



## HPX RUPTURE DISCS

The HPX Rupture Disc is a semicircular scored reverse acting rupture disc that is ideal for liquid or gas/vapor applications.

Each lot of rupture discs is built to order per the specifications of each overpressure relief requirement in your plant. Each lot is then performance tested to provide reliable performance in your plant during normal operations and in overpressure conditions. Each HPX Rupture Disc is proof pressure-tested prior to shipment.

Optimum material thickness and manufacturing tooling design provide not only the full opening and accurate burst rating you expect, but also longer service life at higher operating-to-burst pressure ratios demanded by today's process industries.

### Applications

Due to its high performance operating capabilities, range of burst ratings and materials of construction, the HPX Rupture Disc is the ideal product to use in plants where production includes batch processing runs where operating conditions and media may change frequently. The variability offered by HPX Rupture Discs makes future modifications to specifications easier to incorporate in change control procedures and without piping modifications.



The HPX Rupture Disc can be used in a wide range of applications in many different industries:

- CHEMICAL** // Reactors, Heat Exchangers, Chillers, Relief Valve Isolation
- OIL & GAS** // Distillation Columns, Separators, Coking Drums
- PHARMACEUTICAL** // Production Vessels, Blending and Milling Vessels
- INDUSTRIAL GAS** // Process Columns and Vessels, Storage and Transportation Tanks and Trailers

## Optional Features

- **Fluoropolymer liner is available** for corrosion protection on the process side of the rupture disc.<sup>1</sup>
- **Fluoropolymer outlet protective cover available** for corrosion protection on vent side of rupture disc/holder.
- **Fluoropolymer coating available** for corrosion protection on process and/or vent side of rupture disc.



- **To optimize service life and rupture disc performance, Continental Disc Corporation manufactures and tests each HPX Rupture Disc order** for compressible or incompressible relief conditions as required by your application. HPX Rupture Discs manufactured and tested only for compressible (gas/vapor) relief conditions may not function properly in an incompressible (liquid) application. Please state in your specifications and orders if a scenario exists for relief of incompressible media or if relief conditions exist only for compressible media.
- **Ideal for liquid or gas/vapor applications.**
- **Available to be cleaned** for Oxygen or Chlorine Service.

## BURST PRESSURES //

This table shows burst pressures available at 72°F (22°C)

SIZE	NICKEL, MONEL®		316 SS / 316L SS, INCONEL®		HASTELLOY® C	
	MINIMUM	MAXIMUM	MINIMUM	MAXIMUM	MINIMUM	MAXIMUM
	psig/ barg	psig/ barg	psig/ barg	psig/ barg	psig/ barg	psig/ barg
1"	15	1100	15	1440	30	2000
25 mm	1,03	75,9	1,03	99,3	2,07	138
1½"	10	990	10	1250	20	1800
40 mm	0,689	68,3	0,689	86,2	1,38	124
2"	10	935	10	1100	15	1440
50 mm	0,689	64,5	0,689	75,9	1,03	99,3
3"	10	925	10	1200	15	1200
80 mm	0,689	63,8	0,689	82,8	1,03	82,8
4"	10	715	10	920	15	1035
100 mm	0,689	49,3	0,689	63,4	1,03	71,4
6"	10	440	10	515	15	575
150 mm	0,689	30,3	0,689	35,5	1,03	39,7
8"	10	275	10	345	15	385
200 mm	0,689	19,0	0,689	23,8	1,03	26,6
10"	15	225	20	275	30	325
250 mm	1,03	15,5	1,38	18,9	2,07	22,4
12"	15	190	20	225	30	270
300 mm	1,03	13,1	1,38	15,5	2,07	18,6

## MAXIMUM RECOMMENDED TEMPERATURE LIMITS

DISC MATERIAL	°F	°C
Nickel	800	427
MONEL®	800	427
316 SS/316L SS	900	482
HASTELLOY® C	900	482
INCONEL®	1000	538
Fluoropolymer Liner	500	260



Minimum and Maximum pressures are based upon the corresponding minimum and maximum of the manufacturing range at 72°F (22°C).

<sup>1</sup> Fluoropolymer liners are available for: 1", 1.5" discs rated > 30 psig @ 72°F // 2" - 12" discs rated > 25 psig @ 72°F

**BURST  
PRESSURE  
RATINGS //**  
HPX FAMILY

## HPX Product Family Standard Burst Pressure Rating Types

The rupture discs in the following tables illustrate:

- Standard burst pressure rating types and ranges available
- The associated tolerances for the burst pressure rating
- How to determine the maximum recommended operating pressure

*Special ranges are available upon request.*

### Keep in mind:

- For compliance to ASME Section VIII, Division 1, the **RATED** rating type must be used
- For compliance with Pressure Equipment Directive (PED) (to carry the CE Mark) and the ISO 4126-2 standard, either the **SPECIFIED** or **MIN/MAX** rating type must be used



FOR MORE INFORMATION ON RATING TYPES, PLEASE SEE THE: [BURST RATING TYPES DATASHEET](#)



RATED RUPTURE DISC RATING TYPE				
PRODUCT	RATED BURST PRESSURE	MANUFACTURING RANGE	BURST TOLERANCE AROUND RATED (MARKED) BURST PRESSURE	MAXIMUM RECOMMENDED OPERATING PRESSURE
HPX-95 SANITRX HPX-95 SANITRX HPX II-95	above 40 psig above 2,76 barg	Zero	-5% / +5%	95% of Rated (Marked) Burst Pressure
	up to and including 40 psig up to and including 2,76 barg		-2 psig / +2 psig -0,138 barg / +0,138 barg	95% of [Rated (Marked) Burst Pressure - 2 psig] 95% of [Rated (Marked) Burst Pressure - 0,138 barg]
HPX-90 HPX-Ta SANITRX HPX-90 SANITRX HPX II-90	above 50 psig above 3,45 barg	Zero	-5% / +5%	90% of Rated (Marked) Burst Pressure
		-5%		
		-10%		
	above 40 up to and including 50 psig above 2,76 up to and including 3,45 barg	Zero		
		-2.5 psig -0,173 barg		
		-5 psig -0,345 barg		
up to and including 40 psig up to and including 2,76 barg	Zero	-2 psig / +2 psig -0,138 barg / +0,138 barg	90% of [Rated (Marked) Burst Pressure - 2 psig] 90% of [Rated (Marked) Burst Pressure - 0,138 barg]	
	-2.5 psig -0,173 barg			
	-5 psig -0,345 barg			

*Rating and Range is based on psig values, barg values are provided for reference*

## SPECIFIED RUPTURE DISC RATING TYPE

PRODUCT	SPECIFIED BURST PRESSURE	PERFORMANCE TOLERANCE	EQUIVALENT MANUFACTURING RANGE	MAXIMUM RECOMMENDED OPERATING PRESSURE	
HPX-95 SANITRX HPX-95 SANITRX HPX II-95	above 40 psig above 2,76 barg	-5% / +5%	Zero	100% of Min of Performance Tolerance	
	up to and including 40 psig up to and including 2,76 barg	-2 psig / +2 psig -0,138 barg / +0,138 barg		95% of Min of Performance Tolerance	
HPX-90 HPX-Ta SANITRX HPX-90 SANITRX HPX II-90	above 50 psig above 3,45 barg	-5% / +5%	Zero	95% of Min of Performance Tolerance	
		-9.75% / +5%	-5%		
		-14.5% / +5%	-10%		
	above 40 up to and including 50 psig above 2,76 up to and including 3,45 barg	-5% / +5%	Zero		
		$\left( \frac{[SPEC -2.5 \text{ psig}] 0.95}{SPEC} -1 \right) 100\% / +5\%$	-2.5 psig -0,173 barg		
		$\left( \frac{[SPEC -0.173 \text{ barg}] 0.95}{SPEC} -1 \right) 100\% / +5\%$	-5 psig -0,345 barg		
	up to and including 40 psig up to and including 2,76 barg	-2 psig / +2 psig -0,138 barg / +0,138 barg	Zero		90% of Min of Performance Tolerance
		-4.5 psig / +2 psig -0,311 barg / +0,138 barg	-2.5 psig -0,173 barg		
		-7 psig / +2 psig -0,483 barg / +0,138 barg	-5 psig -0,345 barg		

In table: SPEC = Specified Burst Pressure  
Rating and Range is based on psig values, barg values are provided for reference

**BURST PRESSURE RATINGS //**  
HPX FAMILY



## MIN/MAX RUPTURE DISC RATING TYPE

PRODUCT	MAX BURST PRESSURE	MIN =	EQUIVALENT MANUFACTURING RANGE	MAXIMUM RECOMMENDED OPERATING PRESSURE	
HPX-95 SANITRX HPX-95 SANITRX HPX II-95	above 42 psig above 2,90 barg	MAX / 1.05 x 0.95	Zero	100% of MIN Burst Pressure	
	up to and including 42 psig up to and including 2,90 barg	MAX - 4 psig MAX - 0,276 barg		95% of MIN Burst Pressure	
HPX-90 HPX-Ta SANITRX HPX-90 SANITRX HPX II-90	above 52.5 psig above 3,62 barg	MAX / 1.05 x 0.95	Zero	95% of MIN Burst Pressure	
		MAX / 1.05 x 0.95 x 0.95	-5%		
		MAX / 1.05 x 0.9 x 0.95	-10%		
	above 42 up to and including 52.5 psig above 2,90 up to and including 3,62 barg	MAX / 1.05 x 0.95	Zero		
		$(MAX / 1.05 - 2.5 \text{ psig}) 0.95$ $(MAX / 1,05 - 0,173 \text{ barg}) 0,95$	-2.5 psig -0,173 barg		
		$(MAX / 1.05 - 5 \text{ psig}) 0.95$ $(MAX / 1,05 - 0,345 \text{ barg}) 0,95$	-5 psig -0,345 barg		
	up to and including 42 psig up to and including 2,90 barg	MAX - 4 psig MAX - 0,276 barg	Zero		90% of MIN Burst Pressure
		MAX - 6.5 psig MAX - 0,449 barg	-2.5 psig -0,173 barg		
		MAX - 9 psig MAX - 0,621 barg	-5 psig -0,345 barg		

In table: MAX = MAX Burst Pressure and MIN = MIN Burst Pressure  
Rating and Range is based on psig values, barg values are provided for reference

## INDUSTRIAL HPX HOLDERS

### INDUSTRIAL HOLDERS // HPX FAMILY

Our holders are designed to optimize flow, assure proper orientation of the HPX Rupture Disc in your piping system, provide a tight seal and prevent fragmentation of the rupture disc.

### Features:

- **Flow optimization of the HPX holder and rupture disc assembly** is characterized by best-in-class certified  $K_R$  factors of 0.29 for gas/vapor relief or 0.38 for liquid relief for the Insert and HPX-PT Holders, and a  $K_{RGL}$  factor of 0.97 for gas/vapor/liquid relief for the Double Disc holder.
- **Proper orientation of the rupture disc in the holder is assured by the three alignment pins** in the holder inlet that properly align and orient the rupture disc in the holder. An optional J-Hook can be used to orient the holder in its mating flanges. The flow arrows on the holder and rupture disc tags confirm proper flow direction.
- **A durable tapered sealing surface on the holder inlet that, along with proper installation and handling, provides a bubble-tight (no air bubbles detected with leak detection fluid) metal-to-metal seal** between the holder inlet and rupture disc. Contact your sales representative for specific leak rate or leak testing requirements.
- **The holder outlet bore incorporates an arcuate that provides a radiused hinge** for the rupture disc petal to form around preventing fragmentation of the rupture disc.
- **1"-8" HPX holders can be directly coupled with a safety relief valve.** HPX-RH and HPX-PT-RH are not designed to be directly coupled with a safety relief valve. The 10" (250 mm) and 12" (300 mm) HPX holders require a spool piece when used under a safety relief valve. *(For more details, see the HPX Installation Instructions on [www.contdisc.com](http://www.contdisc.com))*
- **The holder inlet protects the rupture disc dome** during installation of the assembly into the piping system.
- **As a standard, the holder will come with spiral groove facing per ASME B16.5**, which will provide a surface finish between 125 and 250 microinches (3,2 to 6,3 micrometers).

### Additional Features:

Holder assemblies are made from standard materials including Carbon Steel, 316SS, HASTELLOY® C and MONEL®. Other materials are available on request.

HPX Rupture Disc insert holders are available for ASME, JIS or DIN class flanges as shown on the following table. Consult your sales representative for holders to fit other national or international standards or flange classes not shown.





HPX INSERT & HPX-RH (Reduced Height) INSERT HOLDER // Weights & Dimensions

NOMINAL SIZE	ASME		DIN		JIS		HPX INSERT HOLDER HEIGHT (in/mm)	HPX-RH HOLDER HEIGHT (in/mm)	HPX INSERT HOLDER WEIGHT (lb/kg)	HPX-RH HOLDER WEIGHT (lb/kg)
	CLASS	OUTSIDE DIAMETER (in/mm)	CLASS	OUTSIDE DIAMETER (mm)	CLASS	OUTSIDE DIAMETER (mm)				
1" 25 mm	150	2.50 / 63,5					1.80 / 45,7	1.47 / 37,3	2.0 / 0,9	1.5 / 0,7
	300 / 600	2.75 / 69,9	10 / 40	69,9	10 / 20	69,9	1.80 / 45,7	1.47 / 37,3	2.5 / 1,1	1.9 / 0,9
					30 / 40	76,0	1.80 / 45,7	1.47 / 37,3	3.0 / 1,4	2.4 / 1,1
	900 / 1500	3.00 / 76,2					2.40 / 61,0		3.6 / 1,6	
1½" 40 mm			63 / 160	82,0			2.40 / 61,0		3.6 / 1,6	
	150	3.25 / 82,6					2.04 / 51,8	1.67 / 42,4	4.5 / 2,0	2.7 / 1,2
					10 / 20	86,0	2.04 / 51,8	1.67 / 42,4	4.9 / 2,2	3.0 / 1,4
	300 / 600	3.63 / 92,2	10 / 40	92,2			2.04 / 51,8	1.67 / 42,4	4.7 / 2,1	3.7 / 1,7
	900 / 1500	3.75 / 95,3					2.57 / 65,3	2.59 / 65,8	6.4 / 2,9	6.2 / 2,8
2" 50 mm			63 / 160	102,0			2.04 / 51,8	1.67 / 42,4	5.0 / 2,3	4.2 / 1,9
	150	4.00 / 101,6			10 / 20	101,6	2.36 / 59,9	1.80 / 45,7	5.9 / 2,7	4.0 / 1,8
	300 / 600	4.25 / 108,0	10 / 40	108,0			2.36 / 59,9	1.80 / 45,7	6.7 / 3,0	4.9 / 2,2
					30 / 40	111,0	2.36 / 59,9	1.80 / 45,7	7.2 / 3,3	5.3 / 2,4
	900 / 1500	5.50 / 139,7		63			2.36 / 59,9	1.80 / 45,7	7.6 / 3,4	5.3 / 2,4
3" 80 mm							3.06 / 77,7	3.36 / 85,3	17 / 7,7	19 / 8,6
	150	5.25 / 133,4			10	132,0	3.21 / 81,5	2.19 / 55,6	11 / 5,0	9.0 / 4,1
					16 / 20	137,0	3.21 / 81,5	2.19 / 55,6	12 / 5,4	8.0 / 3,6
	300 / 600	5.75 / 146,1	10 / 40	142,0			3.21 / 81,5	2.19 / 55,6	16 / 7,3	8.3 / 3,8
4" 100 mm			63	146,1	30 / 40	146,1	3.21 / 81,5	2.19 / 55,6	21 / 9,5	11 / 5,0
					10	156,0	3.97 / 100,8	2.90 / 73,6	17 / 7,7	12 / 5,4
			10 / 16	162,0	16 / 20	162,0	3.97 / 100,8	2.90 / 73,6	20 / 9,1	14 / 6,3
			25 / 40	168,0	30	168,0	3.97 / 100,8	2.90 / 73,6	23 / 10	16 / 7,3
	150	6.75 / 171,5					3.97 / 100,8	2.90 / 73,6	24 / 11	17 / 7,7
			63	173,0			4.09 / 103,9		25 / 11	
	300	7.00 / 177,8					3.97 / 100,8	2.90 / 73,6	27 / 12	20 / 9,1
6" 150 mm					40	180,1	3.97 / 100,8		28 / 13	
	600	7.50 / 190,5					4.09 / 103,9	2.52 / 64,0	34 / 15	22 / 10
			10 / 16	217,0	10	217,0	5.64 / 143,3	3.64 / 92,5	41 / 19	28 / 13
	150	8.63 / 219,2					5.64 / 143,3	3.64 / 92,5	43 / 20	28 / 13
			25 / 40	223,0			5.64 / 143,3	3.64 / 92,5	62 / 28	30 / 14
	300	9.75 / 247,7			16 / 20	235,0	5.64 / 143,3	3.64 / 92,5	69 / 31	37 / 17
8" 200 mm					30	247,7	5.64 / 143,3	3.64 / 92,5	85 / 39	45 / 20
					40	262,0	5.64 / 143,3	3.64 / 92,5	99 / 45	55 / 25
	600	10.38 / 263,7					5.64 / 143,3	3.08 / 78,2	101 / 46	48 / 22
					10	267,0	7.26 / 184,4	3.77 / 95,8	65 / 30	37 / 17
			10 / 16	273,0			7.26 / 184,4	3.77 / 95,8	73 / 33	44 / 20
	150	10.88 / 276,4					7.26 / 184,4	3.77 / 95,8	78 / 35	44 / 20
10" 250 mm					16 / 20	280,0	7.26 / 184,4	3.77 / 95,8	89 / 40	47 / 21
			25	283,0			7.26 / 184,4	3.77 / 95,8	87 / 40	49 / 22
			40	290,0			7.26 / 184,4	3.77 / 95,8	97 / 44	54 / 25
	300	12.00 / 304,8					7.26 / 184,4	3.77 / 95,8	119 / 54	66 / 30
			10/16	329,0			6.12 / 155,4		75 / 34	
	150	13.25 / 336,6					6.12 / 155,4		89 / 40	
			25	340,0			6.12 / 155,4		96 / 44	
12" 300 mm					16 / 20	353,0	6.12 / 155,4		112 / 51	
					30	357,0	6.12 / 155,4		120 / 54	
	300	14.13 / 358,9					6.12 / 155,4		123 / 56	
					40	377,0	6.12 / 155,4		150 / 68	
			25	400,0			7.12 / 181,8		150 / 68	
	150	16.00 / 406,4			16 / 20	403,0	7.12 / 181,8		154 / 70	
12" 300 mm					30	417,0	7.12 / 181,8		183 / 83	
	300	16.50 / 419,1					7.12 / 181,8		187 / 85	
					40	431,0	7.12 / 181,8		211 / 96	

NOTE: Gauge taps and facing options could affect the holder height and weight.

INDUSTRIAL  
HOLDERS //  
HPX FAMILY



## INDUSTRIAL HOLDERS //

HPX-PT  
PRE-TORQUED  
HOLDER  
ASSEMBLY

HPX-PT® Pre-Torqued Holders incorporate high strength steel socket head cap screws to ensure accurate loading and sealing of the HPX® Rupture Disc. The HPX-PT holder allows the disc to be correctly fitted in the workshop using precise recommended torque levels prior to installation of the complete assembly between the flanges in the process system relief stream.

### COMMON INSTALLATIONS

- Process equipment having glass or fluoropolymer lined flanges that cannot provide the compression required to seal the rupture disc in the holder
- Installations where the piping arrangement restricts access preventing correct torque loading of the flange fasteners
- Challenging processes requiring regular removal of the rupture disc and holder assembly for inspection
- Applications requiring leak testing of the rupture disc assembly prior to installation in the piping system

### FEATURES

- Allows a precise torque load to be applied in the controlled environment of a workshop prior to installation
- Maintains precise loading of the rupture disc where poor flange alignment and gasket cold flow may be an issue
- Pre-torqued holder screws are protected with coating to prevent wear, sticking and galling of the screws, and provides corrosion resistance

NOTE: Pre-torqued holder designs may vary depending on bolting class and size.



HPX-PT PRE-TORQUED HOLDER ASSEMBLY



HPX-PT PRE-TORQUED HOLDER  
WITH SOCKET HEAD CAP SCREWS

## INDUSTRIAL HOLDERS //

HPX-PT  
PRE-TORQUED  
HOLDER  
ASSEMBLY &  
HPX-RH  
REDUCED HEIGHT  
HOLDER



HPX Rupture Disc in HPX-PT Holder

### HPX-PT (PRE-TORQUED) HOLDER // Weights, Bolting Classes & Dimensions

SIZE	BOLTING CLASSES						OUTSIDE DIAMETER	HEIGHT	WEIGHT
	ASME		DIN		JIS				
1" 25 mm	150	300/600	10/40		10/20	30/40	3.63 92,2	1.80 45,7	3.3 1,5
1 1/2" 40 mm	150	300/600	10/40		10/20	30/40	4.63 117,6	2.04 51,8	6.4 2,9
2" 50 mm	150	300/600	10/40		10	16/20 30/40	5.25 133,4	2.36 59,9	9.3 4,2
3" 80 mm	150	300/600	10/40		10	16/20 30/40	7.00 177,8	3.21 81,5	22 10
4" 100 mm	150	300	10/16	25/40	10	16/20 30/40	8.10 205,7	3.97 100,8	34 15
6" 150 mm	150	300	10/16	25/40	10	16/20 30/40	10.44 265,2	5.64 143,3	58 26
8" 200 mm	150	300	10	16	25	40 16/20 30/40	12.88 327,1	7.26 184,4	102 46
10" 250 mm	150	300	25/40		10/16	30/40	15.50 393,7	6.12 155,4	127 58
12" 300 mm	150	300	25/40		16/20	30/40	18.13 460,5	7.12 180,8	209 95



### HPX-PT-RH (PRE-TORQUED/REDUCED HEIGHT) HOLDER // Weights, Bolting Classes & Dimensions

SIZE	BOLTING CLASSES						OUTSIDE DIAMETER	HEIGHT	WEIGHT
	ASME		DIN		JIS				
1" 25 mm	150	300/600	10/40		10/20	30/40	3.63 92,2	1.47 37,3	2.7 1,2
1 1/2" 40 mm	150	300/600	10/40		10/20	30/40	4.63 117,6	1.67 42,4	5.2 2,4
2" 50 mm	150	300/600	10/40		10	16/20 30/40	5.25 133,4	1.80 45,7	7.1 3,2
3" 80 mm	150	300/600	10/40		10	16/20 30/40	7.00 177,8	2.90 73,6	15 6,8
4" 100 mm	150	300	10/16	25/40	10	16/20 30/40	8.10 205,7	2.19 55,6	25 11
6" 150 mm	150	300	10/16	25/40	10	16/20 30/40	10.44 265,2	3.67 93,2	37 17
8" 200 mm	150	300	10	16	25	40 16/20 30/40	12.88 327,2	3.77 95,8	53 24



## INDUSTRIAL HOLDERS //

HPX  
DOUBLE DISC  
HOLDER  
ASSEMBLY

An HPX® Double Disc Assembly consists of three holder components: an inlet, a mid-flange and an outlet piece, along with two rupture discs. The first of the two HPX Rupture Discs is located between the inlet and the mid-flange, and the second HPX Rupture Disc is between the mid-flange and outlet.

This assembly arrangement provides the solution to multiple applications without the need of a more complicated piping arrangement.

### COMMON USES

#### ➤ Rupture Disc Leak Detection

A must with toxic or very valuable contents. Extremely corrosive conditions or damage could cause the process exposed rupture disc to leak. A pressure gauge in the mid-flange would indicate the leak, while a second rupture disc maintains the system leak free. The first rupture disc could then be changed out at an opportune time.

#### ➤ Actuated Rapid Opening Device

By pressurizing the space between the two rupture discs in an HPX Double Disc Assembly, one can obtain a quick opening device. Upon dumping the pressure between the two rupture discs, full open area is obtained within a few milliseconds. An HPX Double Disc Assembly, as a quick opening device, has been used in activating pressure systems, and to test systems for sudden pressure changes.

#### ➤ Elimination of Back Pressure

The second rupture disc withstands the system back pressure, isolating the first rupture disc. Any change in pressure differential across the first rupture disc induced by back pressure is eliminated and it will rupture at its rated burst pressure. The second rupture disc may be rated at a lower burst pressure to compensate for the maximum back pressure that may coincide with a burst condition.

*Please consult your sales representative for more application specifications.*

### AVAILABLE HOLDER OPTION

- A gauge tap is provided in the holder mid-flange...gauge taps in the holder inlet and outlet can be specified.



HPX DOUBLE DISC ASSEMBLY WITH TELL-TALE ASSEMBLY

HPX DOUBLE DISC HOLDER // Weights & Dimensions

NOMINAL SIZE	ASME		DIN		JIS		HPX DOUBLE DISC HOLDER HEIGHT (in/mm)	WEIGHT (lb/kg)
	CLASS	OUTSIDE DIAMETER (in/mm)	CLASS	OUTSIDE DIAMETER (mm)	CLASS	OUTSIDE DIAMETER (mm)		
1" 25 mm	150	2.50 / 63,5					3.92 / 99,5	4.5 / 2,0
	300 / 600	2.75 / 69,9	10 / 40	69,9	10 / 20	69,9	3.92 / 99,5	5.0 / 2,3
					30 / 40	76,0	3.92 / 99,5	5.5 / 2,5
	900 / 1500	3.00 / 76,2					4.52 / 114,8	6.1 / 2,8
1½" 40 mm			63 / 160	82,0			4.52 / 114,8	6.1 / 2,8
	150	3.25 / 82,6					3.96 / 100,6	8.4 / 3,8
					10 / 20	86,0	3.96 / 100,6	8.8 / 4,0
	300 / 600	3.63 / 92,2	10 / 40	92,2			3.96 / 100,6	8.6 / 3,9
	900 / 1500	3.75 / 95,3					4.49 / 114,1	10 / 4,5
2" 50 mm			63 / 160	102,0			4.49 / 114,1	11 / 5,0
	150	4.00 / 101,6			10 / 20	101,6	4.84 / 122,9	12 / 5,4
	300 / 600	4.25 / 108,0	10 / 40	108,0			4.84 / 122,9	13 / 5,9
					30 / 40	111,0	4.84 / 122,9	14 / 6,4
	900 / 1500	5.50 / 139,7	63	113,0			4.84 / 122,9	14 / 6,4
3" 80 mm					10	132,0	6.16 / 156,4	24 / 11
	150	5.25 / 133,4					6.16 / 156,4	25 / 11
			10 / 40	142,0	16 / 20	137,0	6.16 / 156,4	29 / 13
	300 / 600	5.75 / 146,1	63	146,1	30 / 40	146,1	6.16 / 156,4	34 / 15
4" 100 mm					10	156,0	7.42 / 188,4	39 / 18
			10 / 16	162,0	16 / 20	162,0	7.42 / 188,4	42 / 19
			25 / 40	168,0	30	168,0	7.42 / 188,4	45 / 20
	150	6.75 / 171,5	63	173,0			7.42 / 188,4	46 / 21
	300	7.00 / 177,8					7.54 / 191,5	47 / 21
	600	7.50 / 190,5			40	180,1	7.42 / 188,4	49 / 22
6" 150 mm					40	180,1	7.42 / 188,4	50 / 23
			10 / 16	217,0	10	217,0	10.21 / 259,3	95 / 43
	150	8.63 / 219,2					10.21 / 259,3	97 / 44
			25 / 40	223,0			10.21 / 259,3	116 / 53
					16 / 20	235,0	10.21 / 259,3	123 / 56
	300	9.75 / 247,7			30	247,7	10.21 / 259,3	139 / 63
8" 200 mm					40	262,0	10.21 / 259,3	153 / 69
	600	10.38 / 263,7					10.21 / 259,3	155 / 70
			10 / 16	273,0	10	267,0	13.08 / 332,2	161 / 73
							13.08 / 332,2	169 / 77
	150	10.88 / 276,4					13.08 / 332,2	174 / 79
			25	283,0	16 / 20	280,0	13.08 / 332,2	185 / 84
10" 250 mm			40	290,0			13.08 / 332,2	183 / 83
	300	12.00 / 304,8					13.08 / 332,2	193 / 88
			25	340,0			13.08 / 332,2	215 / 98
	150	13.25 / 336,6			10 / 16	353,0	10.25 / 260,4	149 / 69
							10.25 / 260,4	160 / 73
			40	352,0			10.25 / 260,4	187 / 85
12" 300 mm					30	357,0	10.25 / 260,4	189 / 86
	300	14,13 / 358,9					10.25 / 260,4	200 / 90
					40	377,0	10.25 / 260,4	205 / 94
							10.25 / 260,4	250 / 114
			25	400,0			11.87 / 301,5	251 / 114
12" 300 mm					16 / 20	403,0	11.87 / 301,5	257 / 117
	150	16.00 / 406,4					11.87 / 301,5	267 / 122
			40	417,0	30	417,0	11.87 / 301,5	306 / 139
	300	16.50 / 419,1					11.87 / 301,5	312 / 142
				40	431,0	11.87 / 301,5	352 / 160	

NOTE: Gauge taps and facing options could affect the holder height and weight.

INDUSTRIAL HOLDERS // HPX DOUBLE DISC HOLDER ASSEMBLY



## INDUSTRIAL HOLDERS // ACCESSORIES

### INDUSTRIAL HOLDER OPTIONAL ACCESSORIES

**CORROSION RESISTANCE** can be enhanced by fluoropolymer or Tantalum coating of the holder inlet, midflange and/or outlet, or the Tantalum lining of the holder inlet.

- The Tantalum coating utilizes the TANTALINE® process, which creates a pinhole-free, corrosion-resistant barrier of pure Tantalum metal. The Tantalum metal is grown into the substrate metal (typically, 316 stainless steel) and alloy bonded. As a result, typical modes of failure of traditional Tantalum coatings that are sprayed or dipped, such as delamination, chipping and spalling, are virtually non-existent.
- The Tantalum lining process utilizes Tantalum material, which is form-fitted to the wetted surfaces of a 316 SS HPX Rupture Disc holder inlet.

**STUDS AND NUTS** of the appropriate length to engage the HPX Insert Holder with an inlet and outlet flange are available in alloy steel<sup>1</sup> or 316 SS<sup>2</sup> materials.

**TELL-TALE INDICATOR** components between any two inline pressure relief devices can include the following:

- Gauge Taps in the Holder Outlet: 1/4", 3/8" and 1/2" threaded (tap size, location and type may impact holder height)
- Pipe Nipples and Tees, CS or SS: 1/4" or 1/2"
- Excess Flow Valve, 316 SS: 1/4" or 1/2"
- Gauges

**JACKSCREWS**, case hardened steel: 3 per set

**EYEBOLTS**, carbon steel

**CLEANING FOR OXYGEN** or **CHLORINE SERVICE**



<sup>1</sup> ASME SA-193-B7 studs, SA-194-2H nuts

<sup>2</sup> ASME SA-193-B8M Class 2 studs, SA-194-8M nuts

The HPX®-Ta Rupture Disc is a Tantalum semicircular scored reverse acting rupture disc designed specifically for use in highly corrosive media, such as bromine, chlorine, HCL, nitric acid or sulfuric acid. In certain concentrations, temperatures and moisture conditions, Tantalum is frequently the only suitable rupture disc material for the application. HPX holder corrosion resistance can be enhanced by Tantalum lining or coating of the holder components.

## APPLICATIONS

- During the processing of dry chlorine, humidity can enter into the system while pulling a vacuum which increases the mixture of moisture with the chlorine that will corrode other rupture disc materials. To prevent an unplanned shut down for maintenance, the HPX-Ta Rupture Disc is recommended for corrosion resistance where other rupture disc materials are not suitable.
- The HPX-Ta Rupture Discs and HPX-PT (pre-torqued) Holders with Tantalum lining are used in applications where corrosive media is being processed in glass or protective lined vessels. This combination of full Tantalum corrosion protection on the process side of the rupture disc assembly provides the compression required to seal the rupture disc in the holder, which also provides a high level of corrosion resistance and ensures proper installation of the rupture disc assembly.
- The HPX-Ta Rupture Disc with a Tantalum outlet ring which mates with an HPX holder with Tantalum coating on the holder inlet and outlet, provides **complete** corrosion resistance.

## FEATURES

- Compatible with:
  - HPX Insert, HPX-RH (reduced height)
  - HPX-PT (pre-torqued)
  - HPX-PT-RH (reduced height)
  - HPX Double Disc Holders
- Sizes available:
  - 1" – 12" (25mm to 300mm)
- 316 SS standard outlet ring material, HASTELLOY® C, Tantalum and other materials available upon request
- Cyclic durability designed for a minimum of 1,000 cycles from full vacuum to the maximum recommended operating ratio
- In compliance with the Dodd-Frank Act, our Tantalum is procured from conflict-free smelters



HPX-Ta in HPX Insert Holder coated with Tantalum

ADDITIONAL  
INDUSTRIAL  
PRODUCT //

HPX-Ta  
RUPTURE  
DISC



FOR MORE INFORMATION ON THE HPX-Ta, SEE THE: [HPX-Ta TANTALUM RUPTURE DISC DATASHEET](#)



ASME Code Symbol Stamp  
Available When Specified



Pressure Equipment Directive  
Available When Specified



# HPX PRODUCT FAMILY // SANITARY SOLUTIONS

## SANITRX HPX & SANITRX HPX II RUPTURE DISCS

SANITRX HPX & SANITRX HPX II Rupture Discs are semicircular scored reverse acting rupture discs designed specifically for the pharmaceutical, biotech, food and beverage industries. These rupture discs are available to fit between industry standard sanitary ferrules, NA-CONNECT® flanges or SANITRX fittings.

SANITRX HPX & SANITRX HPX II Rupture Discs are shipped in sanitary, environmentally friendly, non-toxic packaging.

### Applications

The SANITRX HPX & SANITRX HPX II Rupture Discs can be used in a wide range of sanitary and hygienic applications throughout pharmaceutical, biotech, food, and beverage facilities. The following list is only a small sample of the many ways in which this outstanding rupture disc can be used:

AUTOCLAVES

BIOREACTORS

CLEAN STEAM PIPING

PROCESS VESSELS

HEAT EXCHANGERS

FILTERS

STORAGE & TRANSPORT VESSELS

MIXING, DRYING, GRANULATING EQUIPMENT

WFI VESSELS & PIPING

LYOPHILIZERS (FREEZE DRYING)

CIP & SIP SKIDS AND PIPING

FERMENTERS







## Features

- To optimize service life and rupture disc performance, Continental Disc Corporation manufactures and tests each SANITRX HPX and SANITRX HPX II Rupture Disc order for compressible or incompressible relief conditions as required by your application. SANITRX HPX and SANITRX HPX II Rupture Discs manufactured and tested only for compressible (gas/vapor) relief conditions may not function properly in an incompressible (liquid) application. Please state in your specifications and orders if a scenario exists for relief of incompressible media or if relief conditions exist only for compressible media.
- Ideal for liquid or gas/vapor applications.
- The SANITRX HPX is also available with a horizontal tag option.



- Optional fluoropolymer coating is available for corrosion protection on the process and/or vent side of the rupture disc.
- Electropolished surface finishes are available as an option.
- ASME Code Section VIII, Division 1 compliant. National Board Certified  $K_R$  flow resistance values:
  - $K_{RG}$  (gas) = 1.13 and  $K_{RL}$  (liquid) = 1.60 for **SANITRX HPX**
  - $K_{RG}$  (gas) = 1.60 and  $K_{RL}$  (liquid) = 1.88 for **SANITRX HPX II**
- For rating, range and tolerance information, please see pages 6-7.

### SANITRX HPX BURST PRESSURES //

The following table shows burst pressures available at 72°F (22°C)

SIZE	316 SS / 316L SS		HASTELLOY® C	
	MINIMUM	MAXIMUM	MINIMUM	MAXIMUM
	psig / barg	psig / barg	psig / barg	psig / barg
1"	25	250	30	250
25 mm	1,72	17,2	2,07	17,2
1½"	10	200	20	200
40 mm	0,689	13,8	1,38	13,8
2"	10	150	15	150
50 mm	0,689	10,3	1,03	10,3
3"	10	100	15	100
80 mm	0,689	6,89	1,03	6,89

Minimum and Maximum pressures are based upon the corresponding minimum and maximum of the manufacturing range at 72°F (22°C).

### SANITRX HPX II BURST PRESSURES //

The following table shows burst pressures available at 72°F (22°C)

SIZE	316 SS / 316L SS		HASTELLOY® C	
	MINIMUM	MAXIMUM	MINIMUM	MAXIMUM
	psig / barg	psig / barg	psig / barg	psig / barg
1½"	200	500	200	500
40 mm	13,8	34,5	13,8	34,5
2"	150	450	150	450
50 mm	10,3	31,0	10,3	31,0
3"	100	175	100	175
80 mm	6,89	12,1	6,89	12,1
4"	10	100	10	100
100 mm	0,689	6,89	0,689	6,89

Minimum and Maximum pressures are based upon the corresponding minimum and maximum of the manufacturing range at 72°F (22°C).



FOR EVEN LOWER PRESSURES, SEE THE [SANITRX LPX DATASHEET](#)

## GASKETS

Standard gaskets are designed for use in industry standard ferrules, SANITRX flat face fittings and NovAseptic NA-CONNECT® Flanges. Replacement slotted gaskets are available upon request. Slotted gaskets of the same material and seat type as the original should be used to maintain the original specifications as shown on the rupture disc tag.

Gasket materials shown in the Gasket Materials and Temperatures table (see below) have been tested and are compliant with USP Class VI, Section <88> Biological Reactivity Tests, "In Vivo". PTFE fluoropolymer gaskets are compliant with FDA CFR Title 21, 177.1550. Materials other than PTFE fluoropolymer and steel reinforced PTFE fluoropolymer shown in the Gasket Materials and Temperatures table are compliant with FDA CFR Title 21, 177.2600. All of these gaskets are free of animal and human derivatives, polishing compounds and release agents.

### GASKET MATERIALS & TEMPERATURES //

The following gasket materials are readily available. *Other materials available upon request.*

GASKET MATERIALS	FDA COMPLIANT	USP CLASS VI COMPLIANT	SERVICE TEMPERATURES				RECOMMENDED FOR USE WITH:		
			MINIMUM		MAXIMUM		SANITARY FITTING CLAMP	MBC® CLAMP	NA-CONNECT® HOLDER
			°F	°C	°F	°C			
Peroxide Cured Silicone	✓	✓	-80	-62	450	232	✓	✓	✓
Platinum Cured Silicone	✓	✓	-80	-62	350	177	✓	✓	✓
White VITON®	✓	✓	-20	-29	400	204	✓	✓	✓
Black VITON®	✓	✓	-20	-29	400	204	✓	✓	✓
White EPDM	✓	✓	-55	-48	275	135	✓	✓	✓
Black EPDM	✓	✓	-55	-48	300	149	✓	✓	✓
PTFE Fluoropolymer	✓	✓	-40	-40	450	232		✓	✓
Steel Reinforced PTFE Fluoropolymer	✓	✓	-20	-29	450	232		✓	

### REPLACEMENT GASKETS

Sanitary slotted replacement gaskets are available for flat face SANITRX (SF) and industry standard (IS) seat types. When replacing gaskets, care must be taken when removing the original gasket, installing the replacement gasket and use of a gasket of the same material and seat type.



SANITARY ACCESSORIES // GASKETS

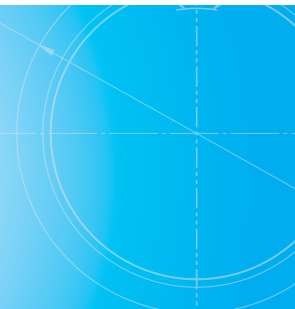

# FITTINGS

Continental Disc Corporation offers ASME BPE and 3A compliant grooved fittings designed for use with the SANITRX HPX Rupture Disc product family.

SANITARY ACCESSORIES // FITTINGS

## SPOOL PIECE

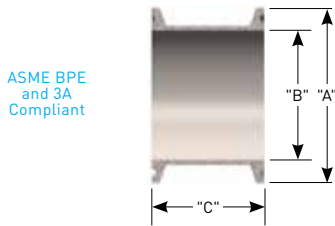

## BUTT WELD FERRULE

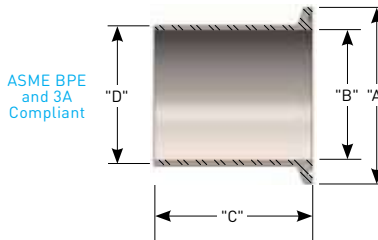

NOMINAL SIZE	DIMENSIONS			WEIGHT	PART NUMBER
	"A" in mm	"B" in mm	"C" in mm	lb kg	
1" 25 mm	1.98	0.85	1.63	0.41	433480050
	50,3	21,6	41,4	0,19	
1 1/2" 40 mm	1.98	1.36	1.63	0.24	433560050
	50,3	34,5	41,4	0,11	
2" 50 mm	2.52	1.86	1.63	0.33	433600050
	64,0	47,2	41,4	0,15	
3" 80 mm	3.58	2.86	2.25	0.64	433620050
	90,9	72,6	57,2	0,29	
4" 100 mm	4.68	3.81	2.25	1.09	433700050
	119	96,8	57,2	0,49	

NOMINAL SIZE	DIMENSIONS				WEIGHT	PART NUMBER
	"A" in mm	"B" in mm	"C" in mm	"D" in mm	lb kg	
1" 25 mm	1.98	0.87	1.75	1.00	0.23	434480050
	50,3	22,1	44,5	25,4	0,10	
1 1/2" 40 mm	1.98	1.37	1.75	1.50	0.21	434560050
	50,3	34,8	44,5	38,1	0,095	
2" 50 mm	2.52	1.87	2.25	2.00	0.34	434600050
	64,0	47,5	57,2	50,8	0,15	
3" 80 mm	3.58	2.87	2.25	3.00	0.53	434620050
	90,9	72,9	57,2	76,2	0,24	
4" 100 mm	4.68	3.83	2.25	4.00	0.90	434700050
	119	97,3	57,2	102	0,41	

## CONCENTRIC REDUCER

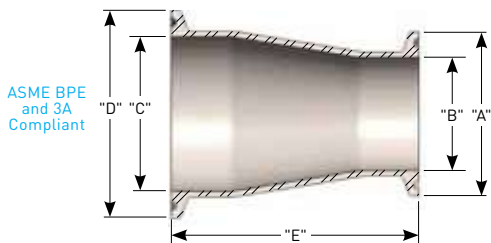

## SPOOL PIECE WITH GAUGE TAP

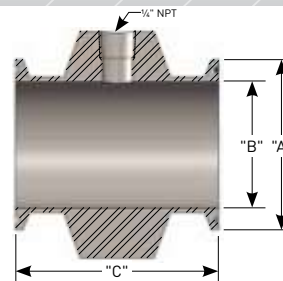

NOMINAL SIZE	DIMENSIONS					WEIGHT	PART NUMBER
	"A" in mm	"B" in mm	"C" in mm	"D" in mm	"E" in mm	lb kg	
1 1/2" x 1" 40 mm x 25 mm	1.98	0.86	1.36	1.98	3.00	0.40	435560050
	50,3	21,8	34,5	50,3	76,2	0,18	
2" x 1 1/2" 50 mm x 40 mm	1.98	1.36	1.86	2.52	3.00	0.45	435600050
	50,3	34,5	47,2	64,0	76,2	0,20	
3" x 2" 80 mm x 50 mm	2.52	1.86	2.86	3.58	5.00	1.00	435620050
	64,0	47,2	72,6	90,9	127	0,45	
4" x 3" 100 mm x 80 mm	3.58	2.86	3.81	4.68	5.13	1.69	435700050
	90,9	72,6	96,8	119	130	0,77	

NOMINAL SIZE	DIMENSIONS			WEIGHT	PART NUMBER
	"A" in mm	"B" in mm	"C" in mm	lb kg	
1" 25 mm	1.98	0.86	3.00	2.84	436483250
	50,3	21,8	76,2	1,29	
1 1/2" 40 mm	1.98	1.36	3.00	2.01	436563250
	50,3	34,5	76,2	0,91	
2" 50 mm	2.51	1.86	3.00	2.54	436603250
	63,8	47,2	76,2	1,15	
3" 80 mm	3.58	2.86	3.00	3.59	436623250
	90,9	72,6	76,2	1,63	
4" 100 mm	4.68	3.81	3.00	4.87	436703250
	119	96,8	76,2	2,21	

NOTE: When using concentric reducers, assure restriction of flow through the reducer is taken into consideration.

## NA-CONNECT® FLANGES

Sanitary rupture discs also specifically fits within the sanitary clamping design of the NovAseptic NA-CONNECT® flanges. This flush-mount holder is becoming increasingly popular in sanitary processing industries because it allows installation of the rupture disc directly against the wall of the vessel to allow for easy cleaning and sterilization.



SANITRX HPX II in NA-CONNECT® FLANGES

# CLAMPS

The SANITRX HPX Rupture Disc product family is designed for installation directly between sanitary tube O.D. connections secured in place with a heavy-duty clamp, such as the Continental Disc MBC™ (Multi-Bolt Clamp) or a Sanitary Fitting Clamp.

## MBC™ Multi-Bolt Clamp

The MBC is a highly durable sanitary clamping device for securing vessel and piping connections in pharmaceutical, biotech, food, beverage, fine chemical, and other sanitary type environments. The multi-bolt clamp design features four stainless steel bolts and nuts securing a two-piece, cast stainless steel body. This sturdy clamp yields the ultimate in connection integrity, providing a dependable, sure-hold for system fittings and components. An opposed multi-bolt pattern, utilizing four bolts, ensures reliable performance and safeguards your system and personnel from possible damage that could result from the failure and release of a clamp relying on only one or two fasteners. The clamp permits installation of the SANITRX HPX Rupture Disc product family, which feature the innovative, attached 3-dimensional flow tag extending beyond the assembly for easy identification of proper rupture disc orientation.

### FEATURES

- Solid, cast stainless steel body with multi-bolt pattern for durability and performance under higher pressures and temperatures.
- Bolts, nuts, and lock washers of corrosion resistant 304 SS construction.
- Available in 1" through 4" sizes
- Depending upon size and limitations of complementary components, the clamp can be installed on systems operating at pressures up to 1500 psig (103 barg) or at temperatures up to 450°F (232°C).

## MBC SPECIFICATIONS

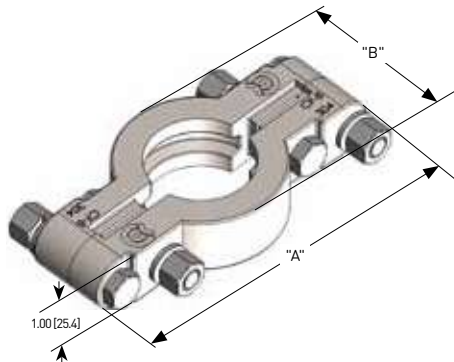

NOMINAL SIZE	DIMENSIONS		WEIGHT lbs kg	CLAMP MAXIMUM OPERATING PRESSURE		PART NUMBER
	"A" in mm	"B" in mm		@ 70°F psig barg	@ 450°F psig barg	
*1½"	5.61	2.71	2.0	1500	500	568560051
40 mm	142	68,8	0,91	103	34,5	
2"	6.11	3.25	2.4	1000	450	568600051
50 mm	155	82,6	1,09	68,9	31,0	568620051
3"	7.12	4.34	3.1	1000	450	
80 mm	181	110	1,41	68,9	31,0	568700051
4"	8.11	5.45	3.4	1000	450	
100 mm	206	138	1,54	68,9	31,0	

\* Use 1 ½" [40mm] clamp for 1" [25mm] connection

MBC clamps, in the size noted, are usable at pressures and temperatures below the appropriate curve

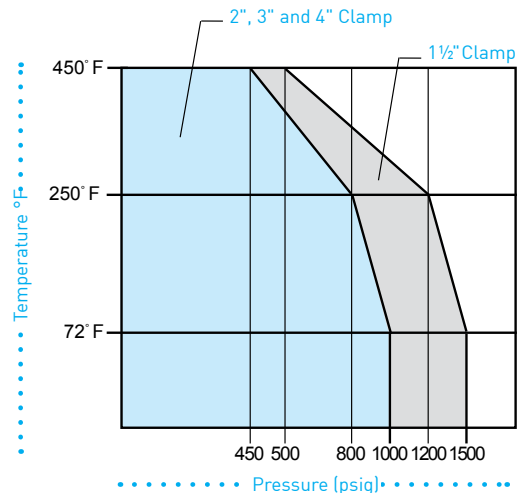

**WARNING:** The MBC™ tables and charts represent the maximum pressure and temperature ratings. Standard sanitary gaskets and fittings may not be designed to withstand the maximum pressure and temperature stated. **It is the responsibility of the user to verify the maximum pressure and temperature rating of the gaskets, fittings and rupture discs.**

SANITARY  
ACCESSORIES //  
MBC™ Clamps

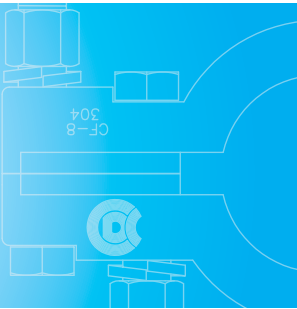

MBC™ CLAMP

## SANITARY FITTING CLAMP SPECIFICATIONS

Clamps are quick-release, easy to change and allow space for the tag extension to pass through the clamp adjacent to the hinge.



NOMINAL SIZE	WEIGHT		CLAMP MAXIMUM		PART NUMBER
	lbs kg	@ 70°F psig barg	@ 250°F psig barg		
*1½" 40 mm	0.62	500	300		013560051
	0,28	34,5	20,7		
2" 50 mm	0.73	450	300		013600051
	0,33	31,0	20,7		
3" 80 mm	1.0	350	195		013620051
	0,45	24,1	13,4		
4" 100 mm	1.1	300	150		013700051
	0,50	20,7	10,3		

\* Use 1 ½" (40mm) clamp for 1" (25mm) connection

## ASME BPE STANDARD

This standard provides requirements applicable to the design of equipment used in the biotech, pharmaceutical and personal care industries including aspects related to sterility and cleanability, materials of construction, dimensions and tolerances, surface finish, material joining and seals.

The standard applies to components in contact with the product, raw materials or intermediates. Systems that are a critical part of the manufacturing process such as water for injection (WFI), clean steam, filtration and intermediate storage may also abide by this standard.

**The SANITRX HPX Rupture Disc product family is in compliance with the essential criteria of the ASME BPE standard as follows:**

- CIP and SIP cleanable
- Withstands temperatures of 130°C where steam sterilization is required
- The standard surface finish meets SF1 (20 Ra microinch) for the SANITRX HPX Rupture Disc product family & the internal surfaces of the ASME BPE compliant sanitary fittings
- The SANITRX HPX Rupture Disc product family gaskets in the **Gasket Materials and Temperatures** table (see page 18) meet ASME BPE requirements, including full traceability and prohibition of animal derivatives
- Rupture discs and fittings are usually, as a standard, made out of 316L SS material; alternates are available if specified by users
- Fully traceable materials
- Fittings are marked and packaged in accordance with ASME BPE
- USP Class VI certified gaskets meet all ASME BPE requirements including full traceability and prohibition of animal derivatives

## SANITARY PACKAGING

The SANITRX HPX product family of rupture discs are shipped in sanitary, non-toxic environmentally-friendly packaging. Benefits include:

- Plastic packaging eliminates direct contact of the rupture disc with open cell material, such as cardboard or foam, which can carry contaminants or leave particles on the rupture disc.
- Clear packaging provides visibility of the rupture disc tag allowing verification of the rupture disc specification without removal from the package.
- The plastic package and cardboard carton are recyclable materials.
- Combined with the vertical tag, the new plastic packaging provides a compact, space saving container for the rupture disc.

## RELATED PRODUCTS //

INDUSTRIAL & SANITARY

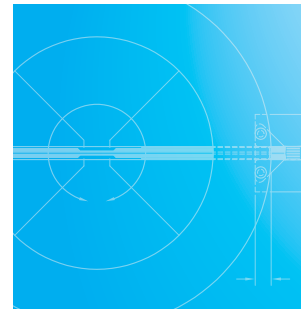

SANITARY FITTINGS,  
CLAMP &  
RUPTURE DISC

## ALARM MONITORS

RELATED  
PRODUCTS //  
INDUSTRIAL &  
SANITARY



BDI-FLX® BURST DISC SENSOR SYSTEM



B.D.I.® ALARM SYSTEM

Continental Disc Corporation provides two systems for monitoring the burst of a rupture disc, the BDI-FLX® Burst Disc Sensor System and the B.D.I.® Alarm System. Common features include:

- Detects venting, provides instantaneous notification of the bursting of a rupture disc.
- Signals emergency equipment, control room and/or operating personnel to alter or stop a process.
- Can be combined with a CDC Alarm Monitor to protect equipment, lives and the environment.

The **BDI-FLX® Burst Disc Sensor System** provides many benefits, which include:

- Allows direct interface to PLC's, DCS (Distributed Control System), alarm monitors or isolating barriers and can provide dry contacts for industrial controls.
- Improved durability:
  - The conductive element is fully encapsulated in corrosive resistant polyimide film
  - The advanced technologies of the sensor strip minimize the risk of damage due to excessive stress beyond recommended bolting load
  - The alignment ring provides a rigid support for the new sensor cable, minimizing cable strain
- Modernized output cable connectors in accordance with IEC 61076-2-101. IP67 rated M12 connector.



FOR MORE INFORMATION ON OUR BDI-FLX® BURST DISC SENSOR SYSTEM, PLEASE SEE THE: [BDI-FLX® BURST DISC SENSOR SYSTEM DATASHEET](#)

The **B.D.I.® Alarm System** provides many benefits, which include:

- Expanded availability in sizes up to 36" (900mm)
- Available as integral design to many rupture disc and vent panel products



FOR MORE INFORMATION ON OUR B.D.I. ALARM SYSTEM, PLEASE SEE THE: [B.D.I.® ALARM SYSTEM DATASHEET](#)

## ENVIRO GUARD® Pipe End Cover

Provide protection of piping, rupture discs, and safety relief valves from unwanted foreign material, rain, insects and/or birds by specifying and installing a ENVIRO GUARD pipe end cover. The ENVIRO GUARD pipe end cover is fabricated from a tough PTFE coated/impregnated fiberglass material suitable for use in harsh environments and temperatures up to 500°F (260°C).



FOR MORE INFORMATION ON OUR ENVIRO GUARD PIPE END COVER, PLEASE SEE THE: [ENVIRO GUARD PIPE END COVERS DATASHEET](#)

# HPX<sup>®</sup> RUPTURE DISCS + PRESSURE RELIEF VALVES

ASME ACCEPTED

## ISOLATION FROM LEAKAGE

Pressure Relief Valves (PRV) can be a significant source of media leakage and emissions. Due to continually tightening government emission standards, small leaks can be more than troublesome...they can be expensive. By isolating the inlet of a PRV with an HPX<sup>®</sup> Rupture Disc, a positive seal is established to minimize leakage and reduce fugitive emissions that can escape through the valve seat.

## ISOLATION FROM CORROSION

Depending upon the corrosive nature of an application's process media, maintaining equipment for long-term service can be expensive due to the costs of exotic materials for PRV components or frequent changeouts caused by equipment deterioration. Isolating a PRV with an HPX<sup>®</sup> Rupture Disc minimizes corrosive effects by preventing continual contact between the PRV's wetted parts and the system media.

## ADVANTAGES

- When in use, HPX<sup>®</sup> Rupture Discs provide a superior process seal reducing fugitive emissions
- PRV's reclose after an overpressure event, saving process media and allowing operation to continue until the HPX<sup>®</sup> Rupture Disc can be replaced
- The HPX<sup>®</sup> Rupture Disc is available in a variety of materials, including 316SS, Alloy 400, Alloy C276 and Tantalum, which allows for the use of less expensive valve materials

## A COMPARISON OF OPTIONS

HPX<sup>®</sup> Rupture Disc available  
in sizes 1"-12" (25mm-300mm)

	PRESSURE RELIEF VALVE	RUPTURE DISC	PRESSURE RELIEF VALVE + RUPTURE DISC
BUBBLE TIGHT*	No	Yes	Yes
COST	High	Low	Medium
MAINTENANCE	High	Low	Medium
ADJUSTABLE	Yes	Fixed Setting	Yes
RECLOSABLE	Yes	No	Yes
REUSABLE	Yes	No	Valve is Reusable Rupture Disc Is Not

\*Bubble-Tight (No air bubbles detected with leak detection fluid) Metal-to-Metal Seal

PRESSURE RELIEF VALVE MODEL	ASME CERTIFIED COMBINATION CAPACITY FACTOR (FOR AIR, GAS & STEAM SERVICE)	MINIMUM SIZE
Anderson Greenwood Crosby JOS-E, JBS-E, JOS-H-E	1.000	1" 25 mm
Broady Flow Control 3500	0.999	1" 25 mm
Consolidated Dresser 1900D-2, 1900-30D-2	0.998	1" 25 mm
Consolidated Dresser 1900E-2, 1900-30E-2	0.995	1" 25 mm
Consolidated Dresser <sup>1</sup> 1900, 1900-30, 1900-35	1.000	1-1/2" 40 mm
Farris 2600, 2600S	0.993	1" 25 mm
LESER 526	1.000	1" 25 mm

Minimum burst pressure: 15 psig (1.03 barg)

ASME certified CCF values apply to all rupture disc materials

1"-8" HPX holders can be directly coupled with a pressure relief valve. HPX-RH and HPX-PT-RH are not designed to be directly coupled with a pressure relief valve. The 10" (250 mm) and 12" (300 mm) HPX holders require a spool piece when used under a pressure relief valve. *[For more details, see the HPX<sup>®</sup> Rupture Disc Installation Instructions on [www.contdisc.com](http://www.contdisc.com)]*



FOR MORE  
INFORMATION,  
PLEASE SEE THE:  
**RUPTURE DISCS +  
PRESSURE RELIEF  
VALVES Brochure**

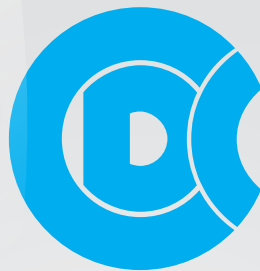

# Continental Disc<sup>®</sup> Corporation

P E R F O R M A N C E   U N D E R   P R E S S U R E <sup>®</sup>



Representante Oficial  
Tel: +54 11 4932-2322  
Email: [ventas@cvcontrol.com.ar](mailto:ventas@cvcontrol.com.ar)  
[www.cvcontrol.com.ar](http://www.cvcontrol.com.ar)

*NOTE: Product parameters are based on United States customary units. Values in metric are provided for reference only.*



#### HEADQUARTERS //

3160 W. Heartland Drive  
Liberty, MO 64068 USA  
Ph (816) 792 1500 | Fax (816) 792 2277  
[sales@contdisc.com](mailto:sales@contdisc.com)

[contdisc.com](http://contdisc.com)

#### THE NETHERLANDS

Energieweg 20  
2382 NJ Zoeterwoude-Rijndijk  
The Netherlands  
Ph +(31) 71 5412221 | Fax +(31) 71 5414361  
[cdcnl@contdisc.com](mailto:cdcnl@contdisc.com)

#### CHINA

Room 1312, Tower B, COFCO Plaza  
No. 8 JianGuoMenNei Avenue  
Beijing (10005), P.R. China  
Ph +(86) 10 522 4885 | Fax +(86) 10 6522 2885  
[cdcchina@contdisc.com](mailto:cdcchina@contdisc.com)

#### INDIA

423/P/11, Mahagujarat Industrial Estate, Moraiya,  
Sarkhej-Bavla Road, Ahmedabad (GJ)  
382213 INDIA  
Ph +(91) 2717 619 333 | Fax +(91) 2717 619 345  
[gcmpl@contdisc.com](mailto:gcmpl@contdisc.com)